

TOMORROW'S
MANUFACTURING
LEADERSHIP
TODAY

Technical Bulletin

Bulletin Number: 287 Revision Number: R-01
Release Date: April 26 1985 Revision Date: July 21, 1992

SUBJECT: ASCEPTIC DUAL PRICE KIT - INSTALLATION INSTRUCTIONS
SEE PAGES 2, 3, AND 4.

ASCEPTIC DUAL PRICE KIT - SINGLE COUNTER
INSTALLATION SEE PAGES 5 AND 6.

MODELS AFFECTED: All DNTP and DNP Asceptic Pre-Series 90
Venders.

REASON: To change a single price vender to a dual (two
price) vender when using a Dual Price Changer.

ORDER: B/M 469,010,200.04 - Two/Four Price Kit
Note: 1 kit will convert 1 vender

Kit Contents:

- 1 - 804,905,020.01 Two/Four Price Conversion Harness
- 2 - 903,828,820.01 Price Decal Sheet, Generic
- 5 - 901,901,060.01 Plastic Wire Ties

IMPORTANT: The Two/Four Price kit does not include
the coin changer. Changers need to be
ordered separately.

Coin Changer Required: Coinco Model D150-9801-907 2 Price

B/M 349,010,200.04	8-Select Two/Four Price Counter Kit
B/M 378,010,200.04	10-Select Two/Four Price Counter Kit

TO INSTALL DUAL PRICE KIT:

1. Unplug the vender.
2. Start with the end of the two/four price kit harness that has the bare changer socket terminals on them. Note, that these wires are numbered 3, 4, 7 and 8. Discard wires which are numbered 4 and 8, they are not used for dual pricing.
3. Remove wire terminals from pins 3 and 7 of the changer socket.

2 Locking Tabs - Socket Terminal

A double blade tool should be used to depress the 2 locking tabs simultaneously to release the terminal.

If terminals 3 & 7 which are removed and taped are used in future to convert back to single price, before reinserting terminal, open the two (2) locking tabs approximately 1/32" to assure locking within the housing.

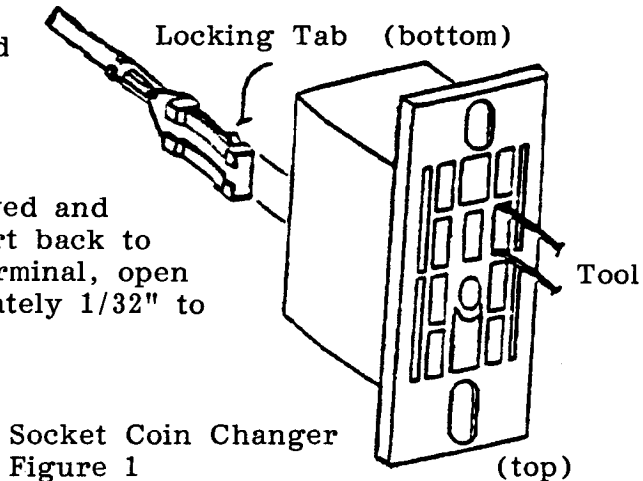

Socket Coin Changer
Figure 1

4. Insert wire number 3 of the two/four price kit in pin 3 of the changer socket. See figure 2 for location of pin 3 in changer socket.
5. Insert wire number 7 of the two/four price kit in pin 7 of the changer socket. See figure 2 for location of pin 7 in changer socket.
6. Unplug the vend relay and store. It will not be used.

Changer Socket
(top view)

Figure 2

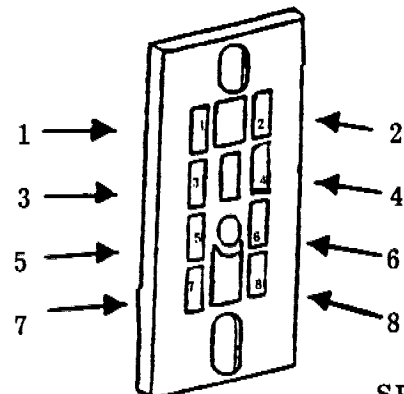

7. Locate wire labeled "A" in the two/four price kit harness.
8. Insert the small tab (metal terminal) on the end of wire "A" in the top of the relay socket at the NC position of SW 1. See figure 3.
Note: NC position of SW 1 has wire number 71 in it. Therefore, wire "A" plugs into wire 71.

Relay Socket
(top view)

Figure 3

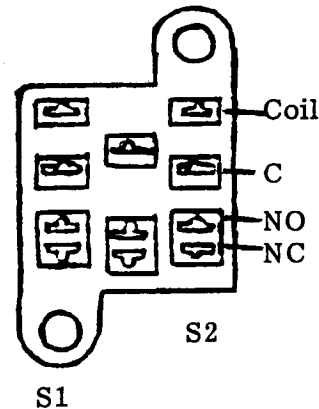

9. Locate the short jumper wire furnished with the two/four price kit harness.
10. Insert one end of the short jumper in the top of the relay socket at the "C" position of SW 1. Insert the other end in the top of the relay socket at position NO of SW 2. (See figure 3.) Note: "C" position of SW 1 has wire number 4 in it and NO position of SW 2 has wire number 10 in it. Therefore, the "jumper wire" plugs in wires 4 and 10.
11. Run the two/four price harness loosely along the existing door harness towards the select panel.
12. Remove the existing wire terminal from the common side of select switch number 3.
13. Plug two/four price kit harness wire number 3 on the common side of select switch number 3.
14. Remove the existing wire terminal from the common side of select switch number 6.
15. Plug the existing wire terminal removed in step 12 on the common side of the select switch number 6.
16. A. On 8 select venders - Remove the existing wire terminal from the common side of select switch number 7.
B. On 10 select venders - Remove the existing wire terminal from the common side of select switch number 9.
17. A. On 8 select venders - Plug two/four price kit harness wire number 7 on the common side of select switch number 7.

- B. On 10 select venders - Plug two\four price kit harness wire number 7 on the common side of select switch number 9.
18. Locate the existing wire terminal removed in step 16 a or b. It should be wire C-25 or T-25.
 19. Plug C-25 or T-25 of existing harness in the wire terminal of wire "A" in two/four price kit harness.
 20. Use plastic wire ties to tie two/four price kit harness to the existing door harness.
 21. SET PRICE SWITCHES IN CHANGER PER INSTRUCTIONS OF CHANGER.
1st Price line will give you a price for selections 1, 2, 3 and 4.
2nd Price line will give you a price for selections 5, 6, 7, and 8 on 8 select venders.
(5, 6, 7, 8, 9, and 10 on 10 select venders)
- NOTE: For other price combinations contact your Dixie-Narco representative or the Dixie Narco Factory Service Department at 800-688-9090.
22. IMPORTANT: Place individual price decals on each select button flavor card and slide card in select button. On permanent type select button flavor cards you will have to install price decal on the front of the select button.

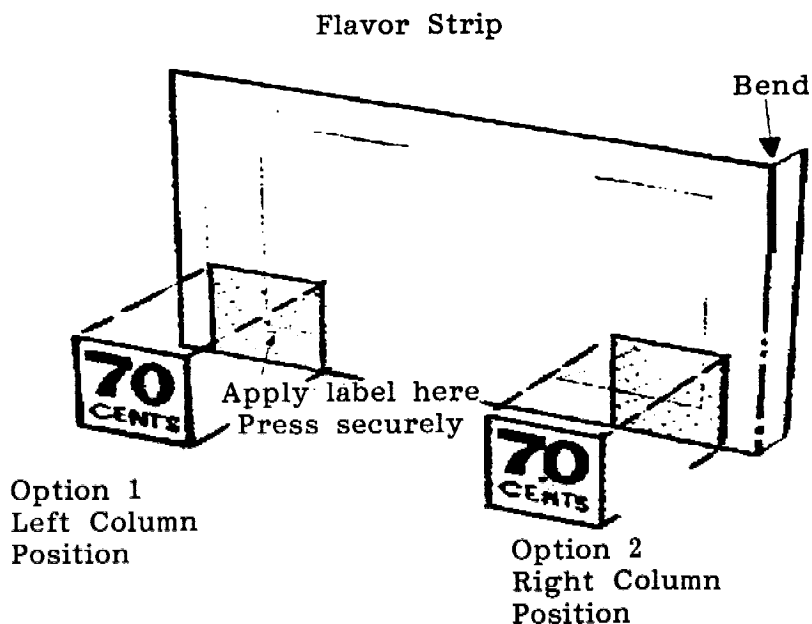

Figure 4

TO INSTALL SINGLE COUNTER:

1. Lay out the short jumpers provided in the kit. Each short jumper is the same length and numbered the same. Each jumper has two identical faston receptacles (See figure 6) and one different terminal (See figure 7).
2. Start with module number 1.
3. Locate the by-pass switch (See figure 5) on the vend motor towards the front of the module. Note there is one (1) unused terminal on the by-pass switch. (i.e. no wire in the NC position)
4. Remove the tri harness/tri harness insulator from the by-pass switch.
5. Place a short jumper so that the wire end marked PCT-5 is toward the rear of the module.
6. Insert one of the wire ends marked PCT-6 (See figure 6) in the unused tri harness insulator removed in step 4. Make sure the wire end is inserted correctly. When inserted correctly it locks in place and will not pull out.
7. Plug the tri harness insulator on the by-pass switch.
8. Remove the tri harness/tri harness insulator from the by-pass switch of the rear vend motor.
9. Insert the other wire end marked PCT-6 (See figure 6) in the unused tri harness insulator removed in step 8. Make sure the wire end is inserted correctly. When inserted correctly it locks in place and will not pull out.
10. Insert the wire end marked PCT-5 (See figure 7) in position 9 of the 9 way cap (See figure 8) at the rear of the module.
11. Repeat steps 1 through 10 for all modules.
12. Remove wire CT in the nine (9) way cap at the bottom of the main door. (See figure 9.)
13. IMPORTANT: Tape the end of CT wire with electrical tape.
14. Lay out the long harness provided in the kit.
15. A. **8-Select Venders** - Insert wire end PCT-1 where wire CT was removed in step 12.
B. **10-Select Venders** - Insert wire end PCT-10 where wire CT was removed in step 12.

16. Insert wire ends PCT-1 and 2 in location 9 of nine (9) way plug at rear of module number 1.
17. Insert wire end PCT-2 and 3 in location 9 of nine (9) way plug at rear of module number 2.
18. Insert wire end PCT-3 and 4 in location 9 of nine (9) way plug at rear of module number 3.
19. A. 8-Select Venders - Insert wire end PCT-4 in location 9 of nine (9) way plug at rear of module number 4.
B. 10-Select Venders - Insert wire end PCT-4 and 11 in location 9 of nine (9) way plug at rear of module 4.
20. 10-Select Venders Only - Insert wire end PCT-11 in location 9 of nine (9) way plug at rear of module 5.
21. Install counter in main door.
22. Plug counter leads in locations 8 and 9 of nine (9) way plug at the bottom of the main door. (See figures 8 & 10.) NOTE: The counter leads will match up to wires PCT-1 and K24/K67 when the nine (9) way plug and cap are plugged together.
23. Plug in vender and test counter for proper operation.

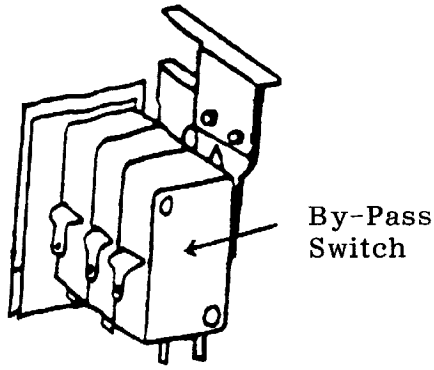
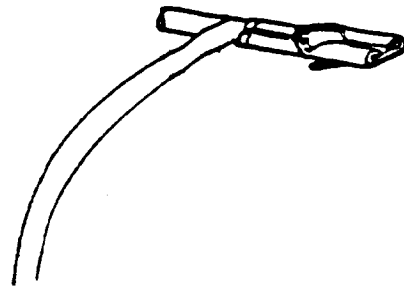
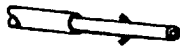

Figure 5



Faston Receptacle
Figure 6



Socket Terminal
Figure 7

As viewed from
wire insertion
side 1 is at
having rib.

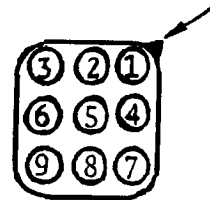

9-Way Plug
Figure 8

